

- ◆ P-Channel Power MOS FET
- ◆ DMOS Structure
- ◆ Low On-State Resistance:  $0.11\Omega$  MAX
- ◆ Ultra High-Speed Switching
- ◆ SOP-8 Package
- ◆ Two FET Devices built-in

### General Description

The XP134A11A1SR is a P-Channel Power MOS FET with low on-state resistance and ultra high-speed switching characteristics. Two FET devices are built into the one package. Because high-speed switching is possible, the IC can be efficiently set thereby saving energy. The small SOP-8 package makes high density mounting possible.

### Applications

- Notebook PCs
- Cellular and portable phones
- On-board power supplies
- Li-ion battery systems

### Features

**Low on-state resistance:**  $R_{ds(on)}=0.065\Omega(V_{gs}=-10V)$   
 $R_{ds(on)}=0.11\Omega(V_{gs}=-4.5V)$

**Ultra high-speed switching**

**Operational Voltage:** -4.5V

**High density mounting:** SOP-8

### Pin Configuration

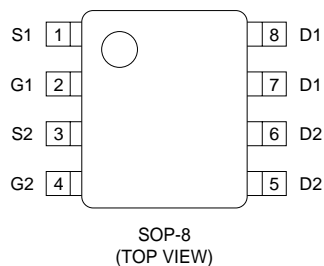

### Pin Assignment

PIN NUMBER	PIN NAME	FUNCTION
1	S1	Source
2	G1	Gate
3	S2	Source
4	G2	Gate
5-6	D2	Drain
7-8	D1	Drain

### Equivalent Circuit

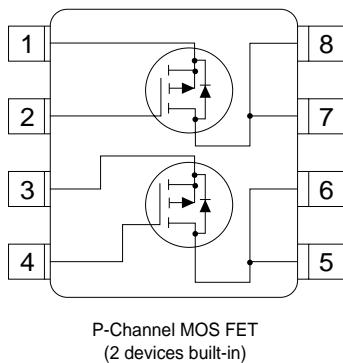

### Absolute Maximum Ratings

$T_a=25^\circ\text{C}$

PARAMETER	SYMBOL	RATINGS	UNITS
Drain-Source Voltage	$V_{dss}$	-30	V
Gate-Source Voltage	$V_{gss}$	$\pm 20$	V
Drain Current (DC)	$I_d$	-4	A
Drain Current (Pulse)	$I_{dp}$	-16	A
Reverse Drain Current	$I_{dr}$	-4	A
Continuous Channel Power Dissipation (note)	$P_d$	2	W
Channel Temperature	$T_{ch}$	150	$^\circ\text{C}$
Storage Temperature	$T_{stg}$	-55~150	$^\circ\text{C}$

Note: When implemented on a glass epoxy PCB

### Electrical Characteristics

#### DC characteristics

Ta=25°C

PARAMETER	SYMBOL	CONDITIONS	MIN	TYP	MAX	UNITS
Drain Cut-off Current	Idss	Vds=-30V, Vgs=0V			-10	μA
Gate-Source Leakage Current	Igss	Vgs=±20V, Vds=0V			±1	μA
Gate-Source Cut-off Voltage	Vgs(off)	Id=-1mA, Vds=-10V	-1.0		-2.5	V
Drain-Source On-state Resistance (note)	Rds(on)	Id=-2A, Vgs=-10V		0.055	0.065	Ω
		Id=-2A, Vgs=-4.5V		0.09	0.11	Ω
Forward Transfer Admittance (note)	Yfs	Id=-2A, Vds=-10V		5		S
Body Drain Diode Forward Voltage	Vf	If=-4A, Vgs=0V		-0.85	-1.1	V

Note: Effective during pulse test.

#### Dynamic characteristics

Ta=25°C

PARAMETER	SYMBOL	CONDITIONS	MIN	TYP	MAX	UNITS
Input Capacitance	Ciss	Vds=-10V, Vgs=0V f=1MHz		680		pF
Output Capacitance	Coss			450		pF
Feedback Capacitance	Crss			170		pF

7

#### Switching characteristics

Ta=25°C

PARAMETER	SYMBOL	CONDITIONS	MIN	TYP	MAX	UNITS	
Turn-on Delay Time	td (on)	Vgs=-5V, Id=-2A Vdd=-10V		15		ns	
Rise Time	tr			20		ns	
Turn-off Delay Time	td (off)				30		ns
Fall Time	tf				20		ns

#### Thermal characteristics

PARAMETER	SYMBOL	CONDITIONS	MIN	TYP	MAX	UNITS
Thermal Resistance (channel-surroundings)	Rth (ch-a)	Implement on a glass epoxy resin PCB		62.5		°C/W

## Electrical Characteristics

Drain Current Vs. Drain / Source Voltage

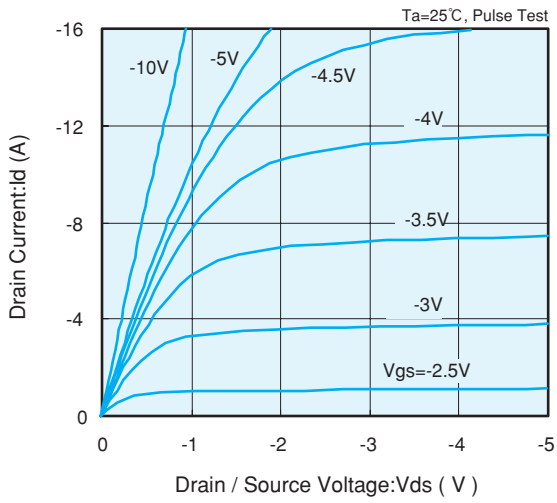

Drain Current Vs. Gate / Source Voltage

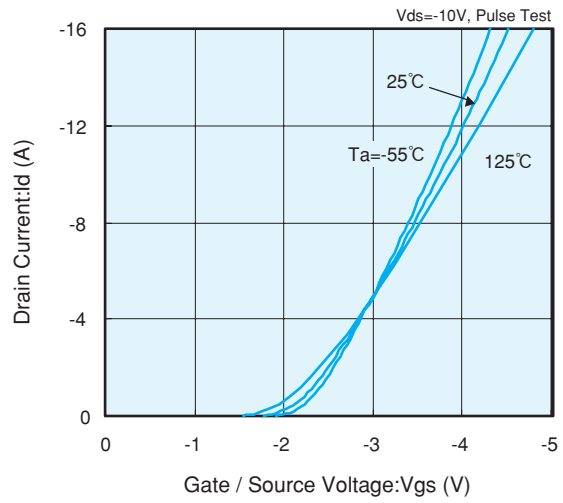

Drain / Source On-State Resistance Vs. Gate / Source Voltage

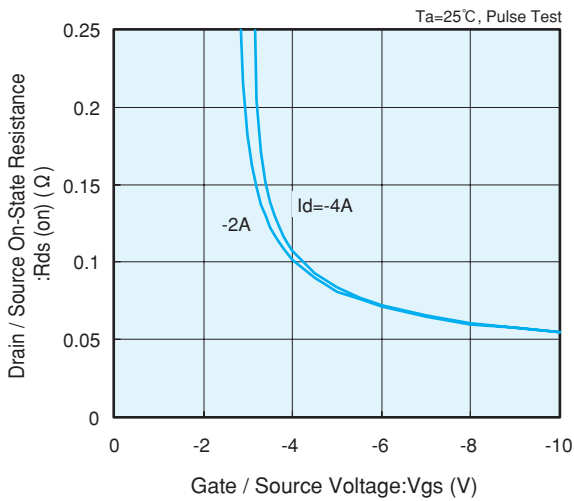

Drain / Source On-State Resistance Vs. Drain Current

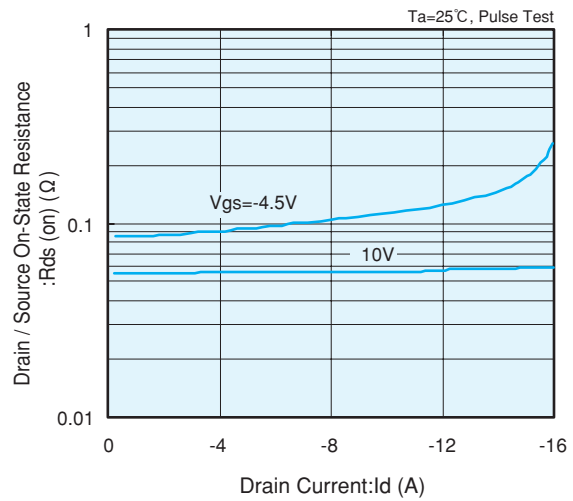

Drain / Source On-State Resistance Vs. Ambient Temp.

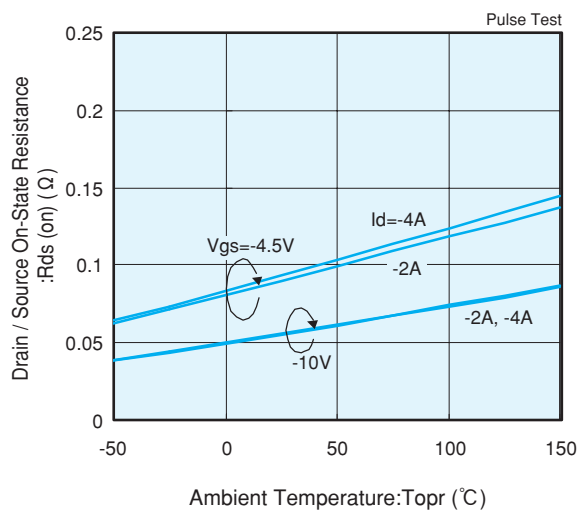

Gate / Source Cut Off Voltage Variance Vs. Ambient Temp.

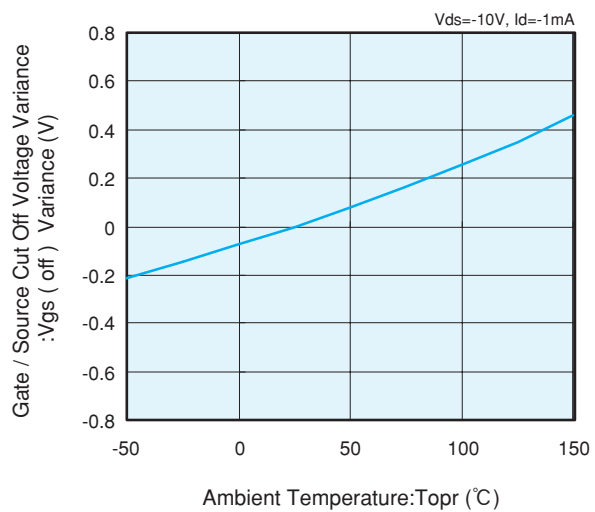

### Electrical Characteristics

Drain / Source Voltage Vs. Capacitance

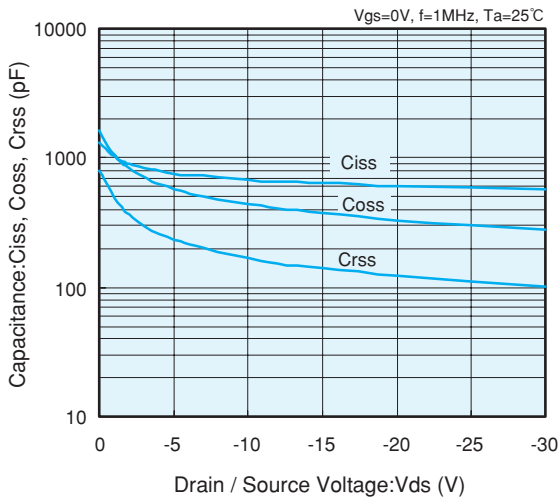

Switching Time Vs. Drain Current

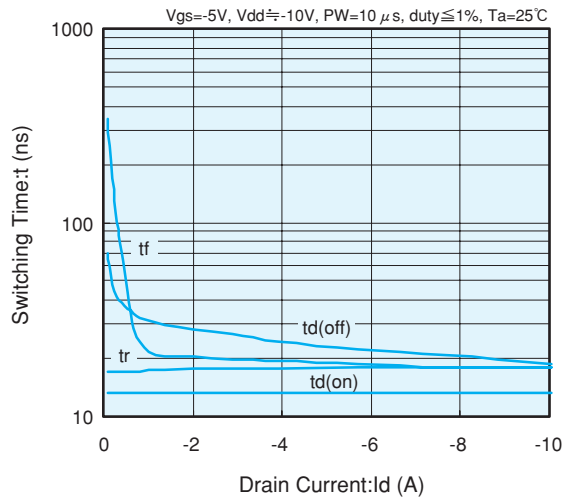

Gate / Source Voltage Vs. Gate Charge

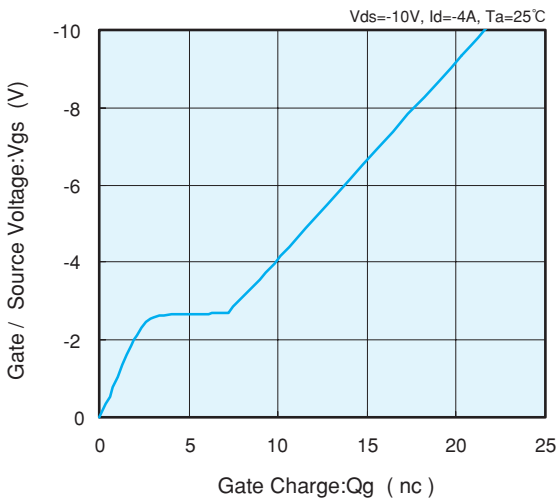

Reverse Drain Current Vs. Source / Drain Voltage

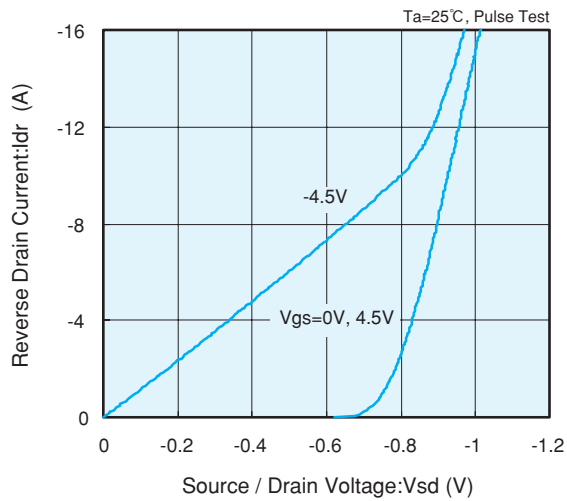

Standardized Transition Thermal Resistance Vs. Pulse Width

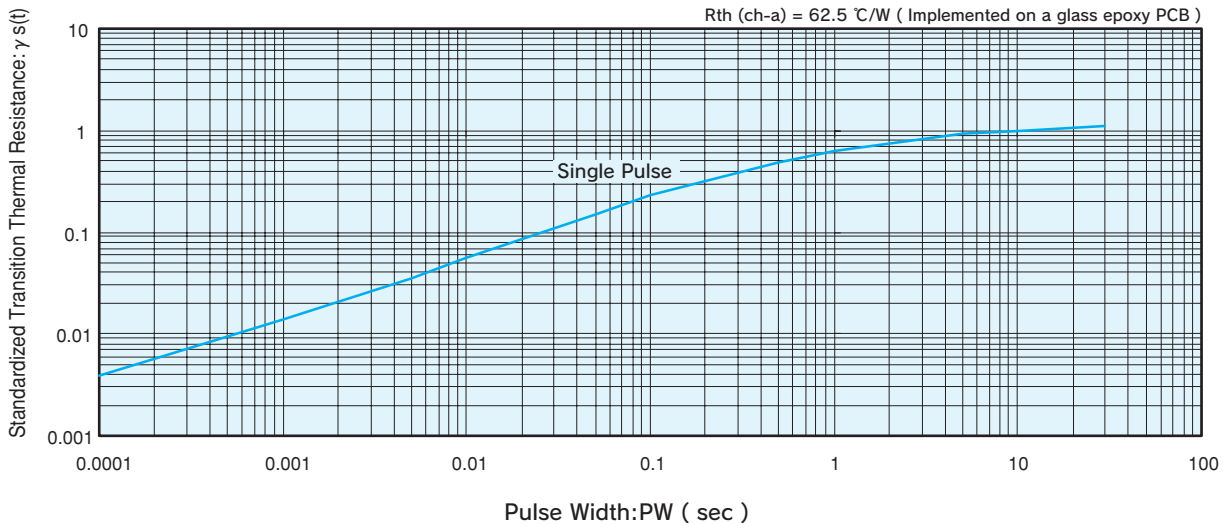

7